



The Clear Choice
Water Filtration Systems



User Manual
AF-30-VT

1.	Functions & Features.....	4
2.	Operation.....	4
3.	Cautions.....	4
4.	Technical information.....	5
5.	The bypass valve.....	5
6.	Controller Operation Instruction.....	5
7.	Inquiring and Establishment of Each Parameter.....	7
8.	Option 1.....	10
8.1.	Option 2 - recommended.....	10
9.	Troubleshooting.....	11



1. Functions & Features

Automatic Valve Control

- 24 hours control and monitoring with a timer; automatically regenerate the media bed at the system's set time of regeneration according to the set regeneration frequency or the water hardness and the balance volume.
- Automatically calculate and design more scientific cycle plan according to the quality of supply water and the user's actual water use.
- Cycle process:
IN SERV.: Supply water with suitable pressure and flow rate flows into softener, and the cations concerns to water hardness(Ca^{2+} , Mg^{2+} , etc.) in the water will be replaced by Na^+ in regenerants, then the softening system supply softened water through its outlet.
Backwash: When the ion exchange resins are out of effect, the resin bed needs to be regenerated. And before the regeneration of resin bed, a backwash step is absolutely necessarily for two main purposes: remove the residuals and resin shatters in the resin bed, and loose the impacted resin bed for a better regeneration efficiency.
Brine: Under certain concentration and flow rate conditions, brine flow through entire resin bed, then the saturated resins will resume their softening capacity.
Rinse: Rinse the resin bed to remove the residual regenerant(salt) in it after Brine step until the water from outlet contains no regenerant; rinse could also impact the resin bed for a better softening effect.
Fill: Refill water to brine tank to dissolve salt for the next regeneration.

PE Brine Tank

- Refill water and salt meet each other in the brine tank, and the salt will dissolve continuously to Water through natural convection until the water is saturated by salts.



2. Operation

This product should be able to put in normal use right after the complete installation and a regeneration test; any other operations are not necessary unless power supply is cut off accidentally;

The softener unit should be installed and prepared by qualified person, any other operations are not necessary while keeping power on all the time and remaining enough salt in brine tank. The only requirements for installation are three water pipe ports (inlet, outlet, drain) and power supply.

Fill resin tank with water (Initial)

- Set the control into the backwash position, then open water supply valve very slowly to approximately the 1/4" open position and let water flow slowly into the resin tank (if open too rapidly or too far, resin may be lost). When all of the air has been purged from the tank (water begins to flow steadily from the drain), open the main supply valve to the full position.
- Drain until the drain water is clear.
- Shut off water supply and let the unit stand for about five minutes to escape all trapped air from the tank.

Refill brine tank

- Manually initiate a whole regeneration cycles after resin tank filling (see Appendix) to fill appropriate water to brine tank.
- Salt level should be higher than water level at first time. There should be enough solid salt anytime. It is recommended to install a bypass system to ensure water supply in any special cases, such as softener failure, maintenance, etc.



3. Cautions

1. Without reading and truly understanding the contents of this user manual, please DO NOT perform any operations on the control valve.
2. Strictly prohibit leaning position when shipping, installing and using this product: Otherwise, it will be damaged inside.
3. During regenerate time, water from tap will NOT be softened. It is NOT recommended to use water during regeneration; otherwise, a negative effect on the regeneration result will occur;
4. Initial a regenerate cycle after being inactivated in a long period of time, and then turn on the tap for several minutes before resuming normal use; DO NOT disconnect power during service time to keep the timer run normal that controls the regeneration function;
5. If the hardness of raw water dramatically changes, change the Water Hardness in the User Setting menu.
6. Hot water could cause severe damage to the softener system; for water boiler and water heater users, ensure the total-run of the piping between the softener and the boiler is not less than 3 meters; it is recommended to install a check valve between the filter and the boiler if unable to meet the required piping length.
7. The input water pressure must be between 0.1 to 0.6 Mpa, no negative water pressure allowed.
8. No chemical allowed at the inlet and outlet connecting sectors. No excessive force which can damage the plastic conjunction parts should be applied by any tools. Besides the machine, spare part connection material doesn't include in scope of manufacturer's warranty.
9. The required environmental temperature for softener is 33.8~102.2oF. Please protect the softener from frozen.
10. Please set up a waterspout on the floor nearby the softener in ease of any leaking accidents.

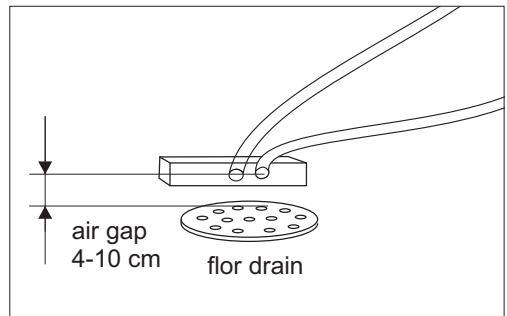

- 11) DO NOT apply any pressure on the softener; avoid exposure to direct sun light and radiation from other heating sources;
- 12) Please select regeneration salt pill as regenerant.



4. Technical information

Controller type – head.....Volume/time
 Size – H x W x L.....1100 mm x 270 mm x 470 mm
 Size of pressure gauge.....10" x 35"
 Tank capacity.....25 dm³
 Brine tank capacity (amount of salt).....50 kg
 Maximum hydraulic flow rate.....2 m³ / h
 Maximum exchange capacity (m³ x °dH).....72
 Maximum water consumption (per regeneration)..0.2 - 0.3 m³
 Maximum salt consumption (kg / regeneration).....3,5
 Flushing performance rate (l / min).....32
 Operating pressure.....1,5 - 5 bar
 Operating temperature.....5°C - 45°C
 Connection/power supply.....100-240V AC 50/60Hz (12VDC 1500 mA)
 Water connection.....3/4" MIP (BSP)

Service position

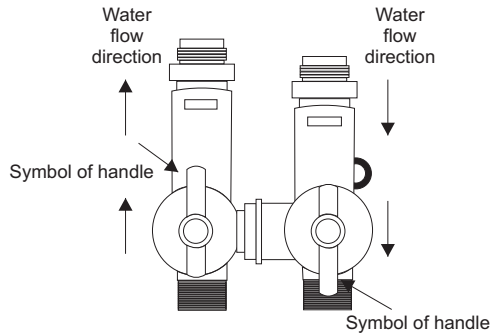

Turn the handle in the position of the picture above. The valve is in service position. Water will flow through the softener valve and be softened.



5. The bypass valve

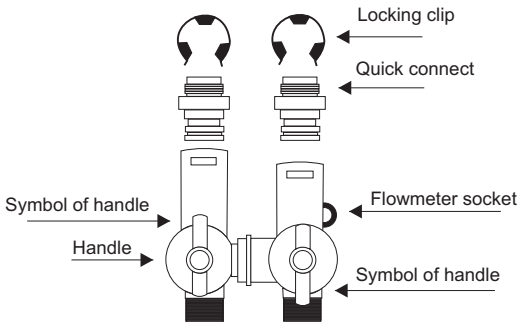

6. Controller Operation Instruction

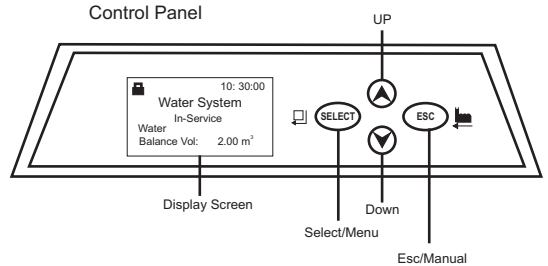

- I. Display Screen
 - a) At service state, the display screen shows the following images every 10 seconds cyclically:

Balance treated water volume, such as 2.00 m³.

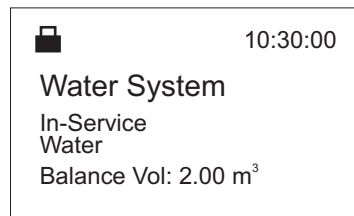

BY-PASS position

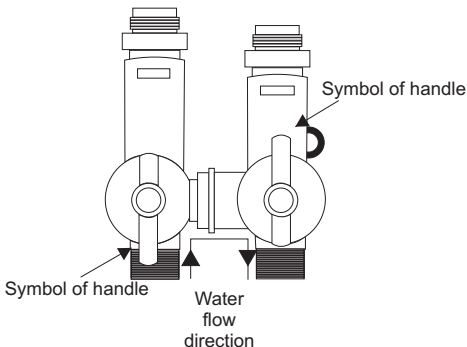

- 5 Turn the handle in the position of the picture above. Then water would be bypassed, it won't be softened and flow out directly.

Current flow rate, such as 1.00 m³/h

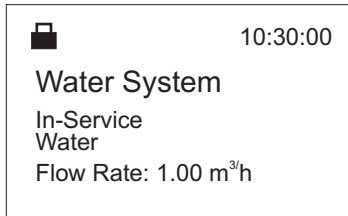

5Min represents the balance time of this state, unit minute, count down.

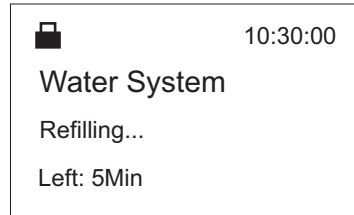

Trig time, such as 02:00.

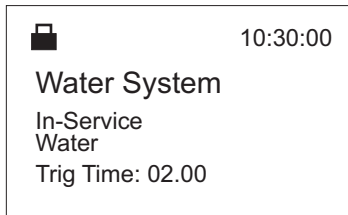

3Min represents the balance time of the state, unit minute, count down.

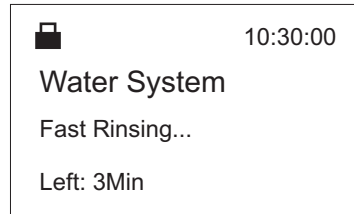

Work state is switching.

When system is at other states, it displays the following

10:30:00 current time, 2Min represents the balance time of this state, unit minute, count down

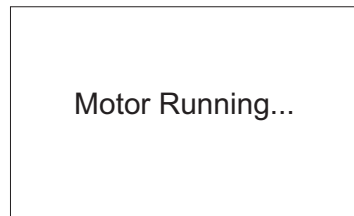
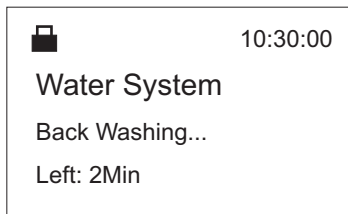

When at key locked state, press any key, it shows this

30Min represents the balance time of this state, unit minute, count down, Down-Flow represents it recharges by down flow.

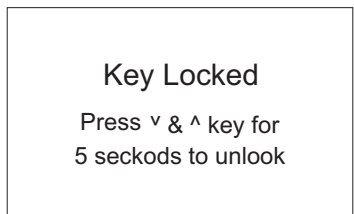
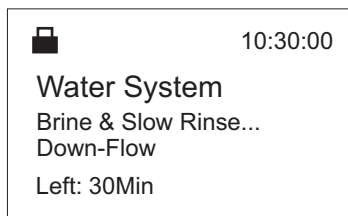

E-01 represents error code.



“Select key”

- Press this key to enter into menu, press Up or Down key, to show each parameter value.
- After entered into menu, press this key again, to show parameter adjusting image, the parameter flickers.
- After setting the parameter, press this key, there is a sound “ding”, to confirm setting and to return to set up state.

“Select key”

- Press this key when not at the menu state, this allow you to finish the current Working state and go to the next Working state immediately. You can control valve manually by pressing this key directly.
- Press this key when in the menu state to go back to the set up menu.
- Press this key when at the setting state (the setting parameter is not saved) to return to set up.

Up and Down keys

- Enter into the menu, press Up or Down, to show each parameter value.
- When setting the parameter, press Up or Down continuously to adjust the parameter.
- Press Up and Down keys together for 5 seconds to unlock.

Another information:

- Current time is 24 hour.
- Flow rate unit: m3. 
- When lights, it represents key locked condition.
- The time on right top corner, it is the current time.
- When pressing the Up or Down key to adjust parameter, a number is changed incrementally per press. Alternatively, press the key and hold for longer than 1.5 seconds, to scroll through numbers incrementally at the rate of 1 every 0.2 seconds. Holding the key longer than three seconds advances the parameter at the rate of 20 per 0.2



7. Inquiring and Establishment of Each Parameter

User setting menu

When keys are not locked, press key to enter into menu.

Soft-Volume Para. Set

- > Set Clock
- Set Rchg Time
- Set Water Hardness

Set Clock menu

Set Clock
09:30

Set Rchg Time set the recharge time.

Set Rchg Time
02:00

Set Water Hardness.

Set Water Hardness
150mg/L

2. Factory Setting

After you turn on the system, during it displays the number of the valve type, **if you press ESC and key at the same time**, it will display the factory setting state.

- > Set Mode-Softener
- Set Valve Mode-F65
- Set Type-Volume
- Set Resin Vol.-08L
- Set RchG Day-30Days
- Set BackWash-02Min
- Set Brine-30Min
- Set Refill-05Min
- Set FastWash-03Min

Caution: The parameters are all set in the factory. So DO NOT change them to prevent unknown errors.

Set Mode

Set Mode
 Purifier
 Softener

Caution: The parameters are all set in the factory. So DO NOT change them to prevent unknown errors.

Set Valve Mode.

Set Valve Mode
 F63
 F65
 F68
 F69
 F82
 F79

Caution: DO NOT change the parameter, otherwise the valve can not work normally.

Set Type

Set Type
 Timer
 Volume

Set Resin Vol.

Set Resin Vol
25 L

Caution: The value of 25 is just taken as an example. DO NOT change the parameter, otherwise the water may not be treated well.

Set Rchg Day
Set max days between recharges.

Set Rchg Day
30 Day

Set Backwash

Set BackWash
02 Min

Set Brine

Set Brine
30 Min

Set Refill

Set Refill
05 Min

Set Fast wash

Set FastWash
03 Min

How to begin a regenerate progress manually

At service state, press the ESC key and you will hear the motor running

The screen shows:

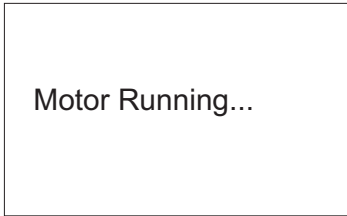

After several seconds, it changes:

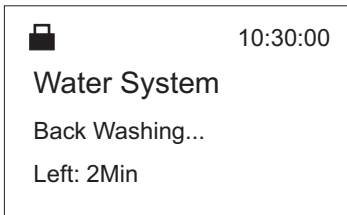

If you want to end up this step, press ESC key again. And the valve would go to the next working state immediately(if not, the valve can complete the regenerate progress itself). The rest working states of a regenerate progress are below:

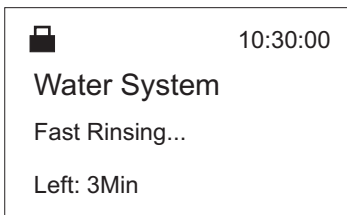
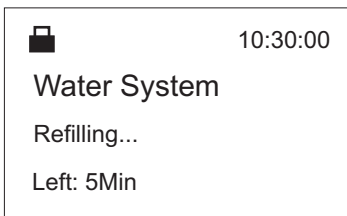
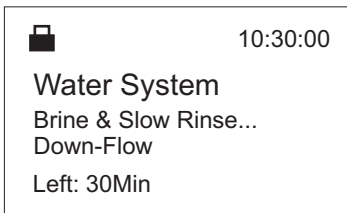



8. Option 1

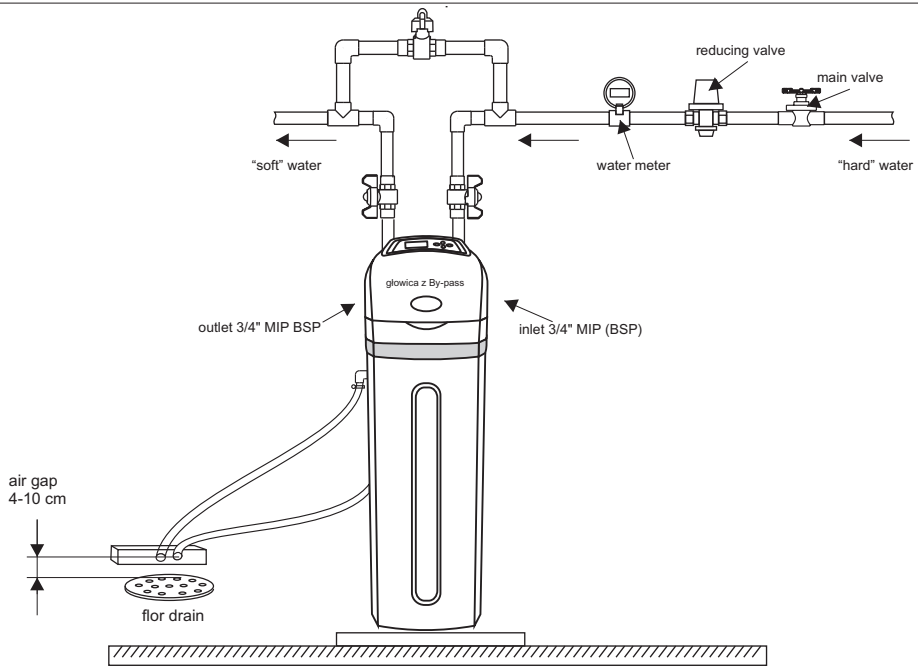

8.1. Option 2 - recommended

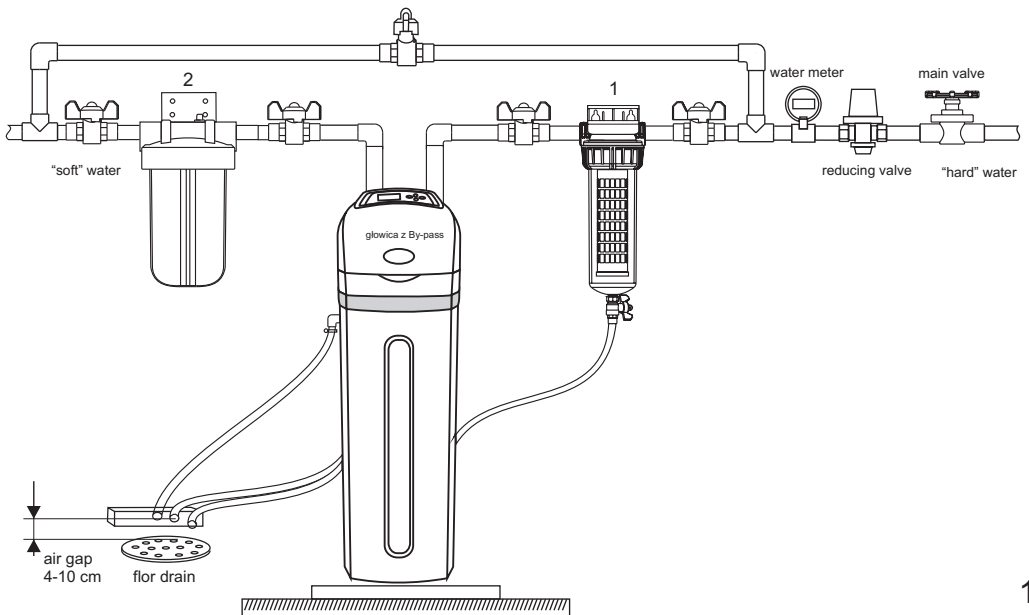



9. Troubleshooting

Troubleshooting		
Problem	Possible Cause	Solution
Controller does not work	1. Transformer is not plugged in 2. Defective power cord 3. Power off 4. Defective transformer	1. Connect to constant power source 2. Replace cord
Incorrect Time of Regeneration	Power outage cause inaccurate timing	According to the User Manual to reset the timer
Leaking	Loose connection	Tighten joints
Noisy	Air exist in the system	Re-backwash the system to vent air
Milk-white water	Air exist in the system	Turn on the tap of vent air
Unsatisfied water hardness	1. Poor raw water quality 2. Time of regeneration is too long 3. Resin disable	1. Call your dealer 2. Reset time of regeneration 3. Re-regeneration or use new resin
Softener fails to use salt	1. Water pressure is too low 2. Brine line plugged 3. Injector is plugged 4. Internal control leak	1. Line pressure must be at least 15 PSI 2. Clean brine line 3. Clean or replace injector and screen 4. Check piston, seals and spacers
Brine container overflow	Refill time disordered	Call your dealer
Water hardness remains	1. Fail to regenerate automatically 2. Brine concentration is poor 3. Injector is plugged	1. Check power controller 2. Keep brine tank full of salt 3. Disassembly the injector and clear it by washing with water
Control backwashes at excessively low or high rate	1. Incorrect backwash controller used 2. Foreign matter affecting controller operation	1. Replace with correct size controller 2. Remove controller and ball Flush with water
Untreated water leakage during service	1. Improper regeneration 2. Leaking of bypass valve 3. O-ring around riser tube damaged 4. Water Hardness in the user setting menu is wrong	1 Repeat regeneration making certain that the correct salt dosage is set 2-3. Replace O-ring 4. Reste the Water Hardness

Important Notices

The controlling components are driven by an electric circuit. Some programmed parameters will be lost as a power outage over 48 hours, and water softener system will carry out the regeneration process at the incorrect time. We strongly recommend that after a power outage, users should check the timer.

Notice: buy the soften salt from the dealer to protect the water softener.

